



US009653877B1

(12) **United States Patent**
Arissian et al.

(10) **Patent No.:** **US 9,653,877 B1**
(45) **Date of Patent:** **May 16, 2017**

- (54) **NESTED FREQUENCY COMBS** 2011/0043815 A1* 2/2011 Giaccari G01J 3/453 356/451
- (71) Applicant: **STC.UNM**, Albuquerque, NM (US) 2011/0110388 A1* 5/2011 Baroni H01S 5/10 372/26
- (72) Inventors: **Ladan Arissian**, Albuquerque, NM (US); **Jean-Claude Diels**, Albuquerque, NM (US) 2015/0198437 A1* 7/2015 Wolf G03F 7/70775 250/372

- (73) Assignee: **STC.UNM**, Albuquerque, NM (US)
- (*) Notice: Subject to any disclaimer, the term of this patent is extended or adjusted under 35 U.S.C. 154(b) by 136 days.

- (21) Appl. No.: **14/537,574**
- (22) Filed: **Nov. 10, 2014**

Related U.S. Application Data

- (60) Provisional application No. 61/902,063, filed on Nov. 8, 2013.

- (51) **Int. Cl.**
G01N 21/41 (2006.01)
H01S 3/106 (2006.01)
- (52) **U.S. Cl.**
CPC **H01S 3/1062** (2013.01); **G01N 21/41** (2013.01); **G01N 21/4133** (2013.01)

- (58) **Field of Classification Search**
CPC .. G01N 21/41; G01N 21/4133; G01N 21/431; G01N 21/43; G01N 21/552
USPC 356/128
See application file for complete search history.

(56) **References Cited**

U.S. PATENT DOCUMENTS

- 8,929,408 B1* 1/2015 Diels H01S 3/1062 372/18
- 2005/0190805 A1* 9/2005 Scripsick H01S 3/0941 372/41

OTHER PUBLICATIONS

Arissian, Ladan, et al., "Investigation of carrier to envelope phase and repetition rate: fingerprints of mode-locked laser cavities", *Journal of Physics B: Atomic, Molecular and Optical Physics* 42, 183001, (2009), 1-25.

Arissian, Ladan, et al., "Repetition rate spectroscopy of the dark line resonance in rubidium", *Optics Communications*, 264, (2006), 169-173.

Hecht, Adam, et al., "A New Method of Radiation Sensing and Analysis", (Abstract), *54th Annual Meeting of the Institute of Nuclear Materials Management (INMM 2013)*, 2 pgs.

* cited by examiner

Primary Examiner — Tarifur Chowdhury
Assistant Examiner — Md M Rahman
(74) *Attorney, Agent, or Firm* — Schwegman Lundberg & Woessner, P.A.

(57) **ABSTRACT**

Apparatus, systems, and methods of generating multi combs can be used in a variety of applications. In various embodiments, a passive resonator can be disposed in the laser cavity of a mode-locked laser to generate a nested frequency comb. The passive resonator can be a sample under investigation, where a characteristic of the sample is determined using the generated nested frequency comb. Additional apparatus, systems, and methods are disclosed.

12 Claims, 16 Drawing Sheets

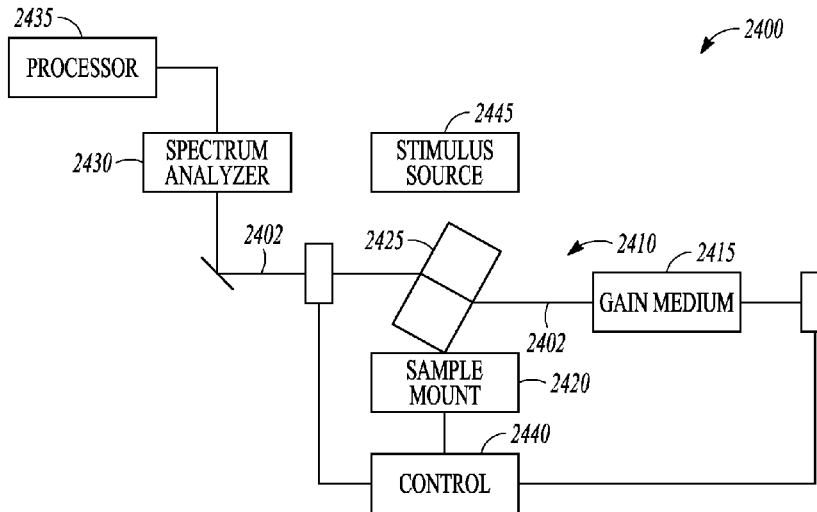

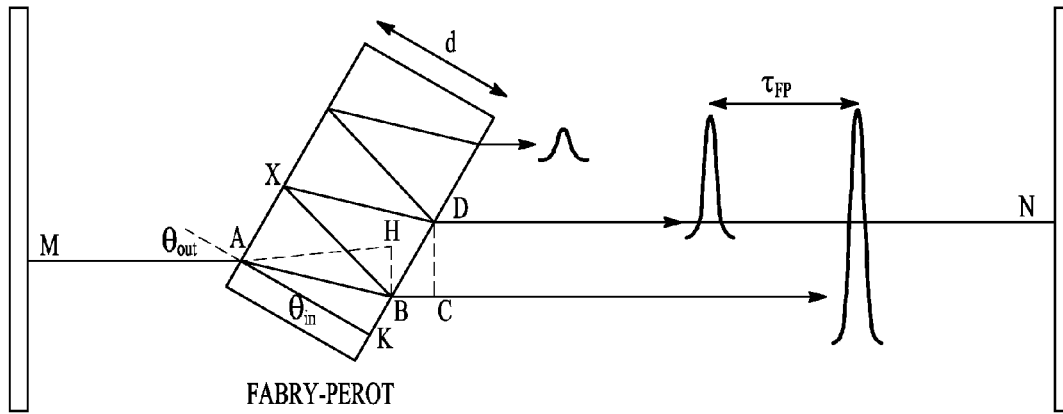

FIG. 1

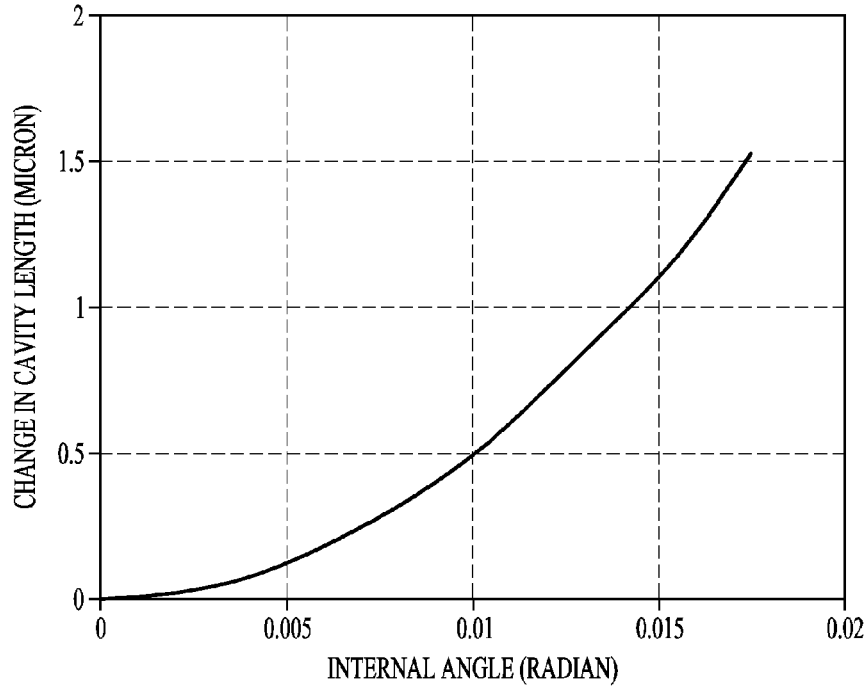

FIG. 2

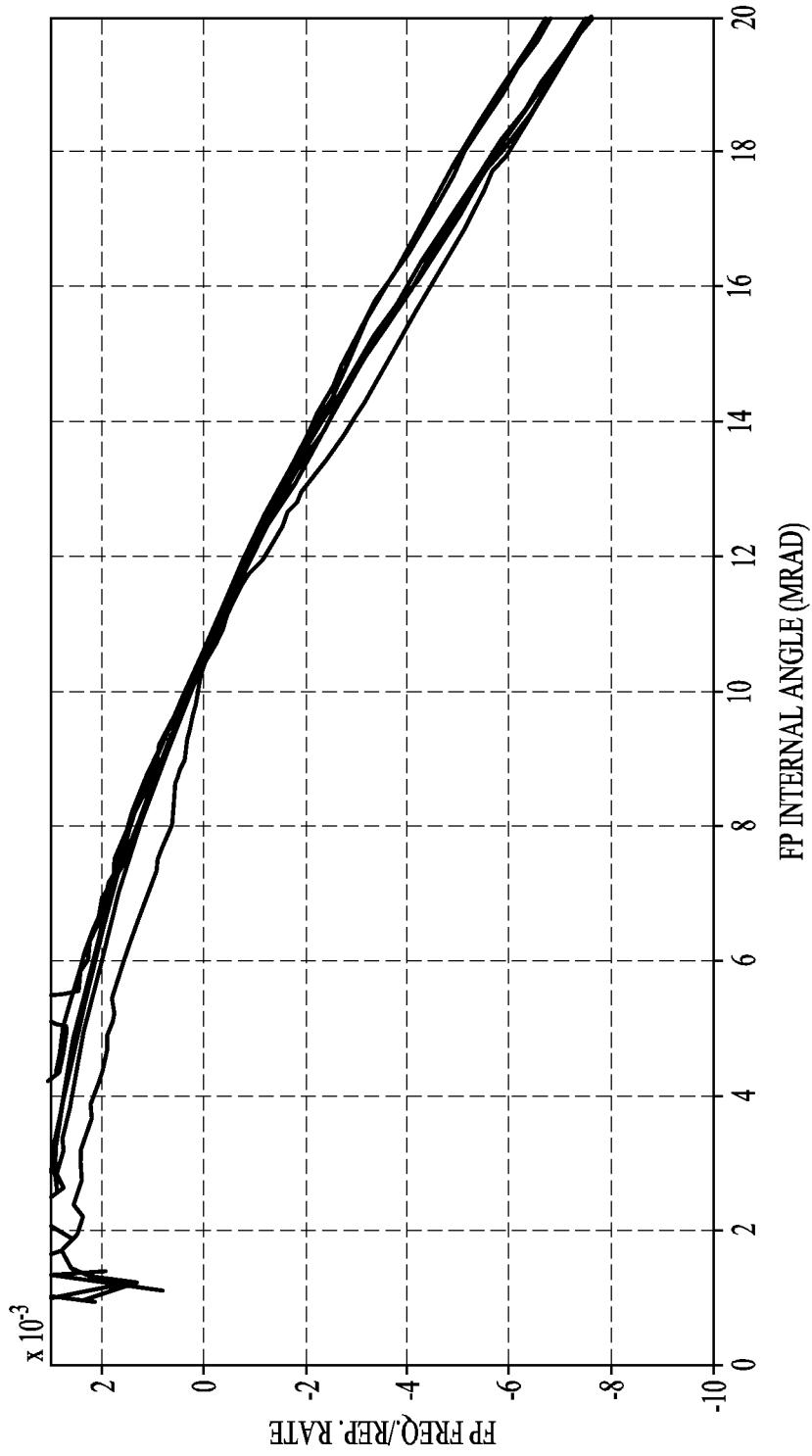

FIG. 3

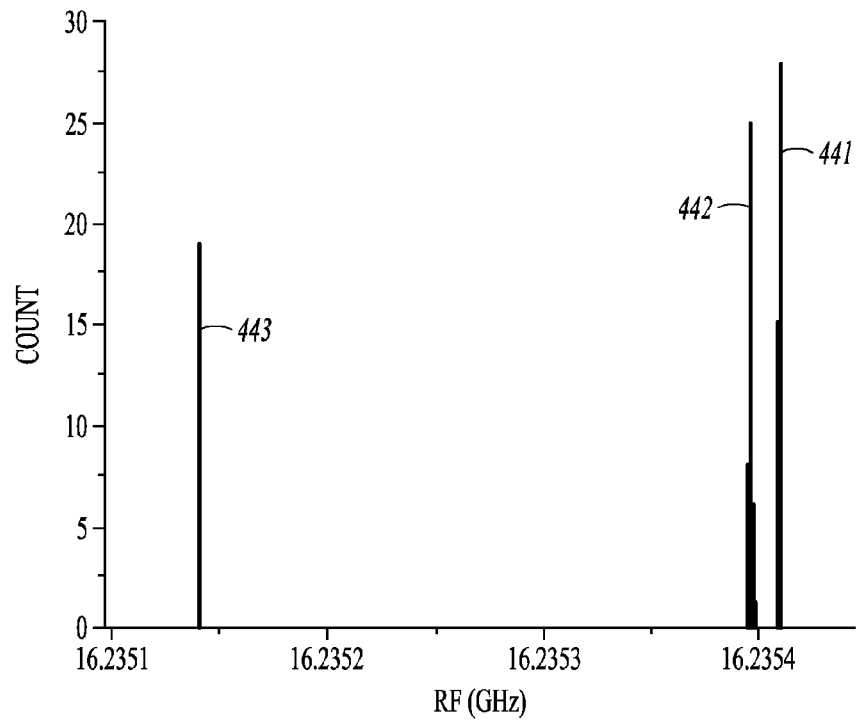

FIG. 4A

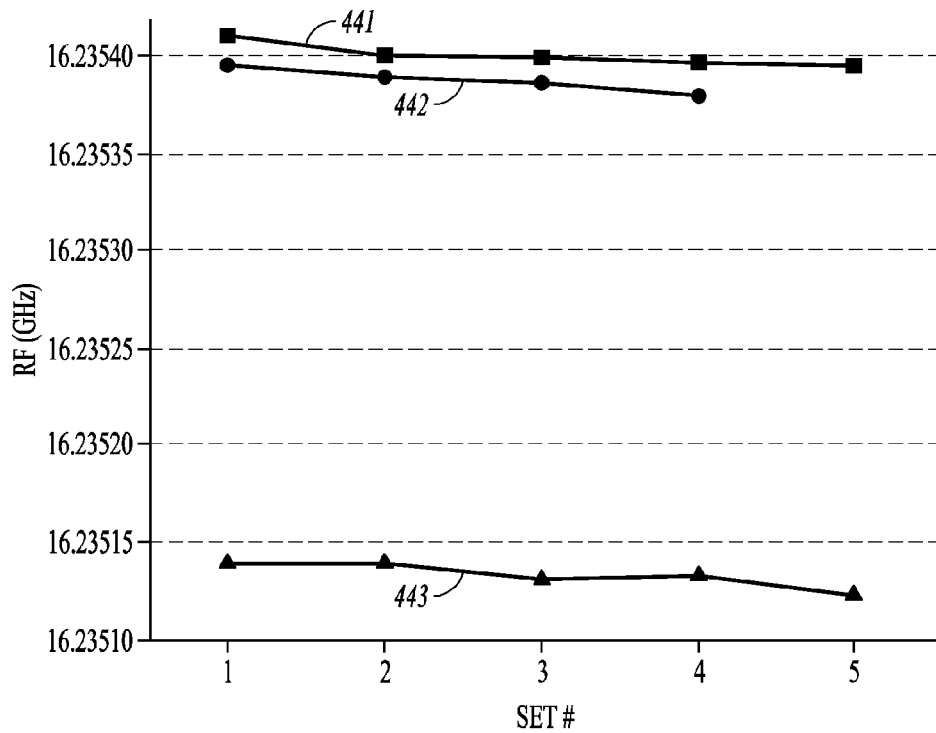

FIG. 4B

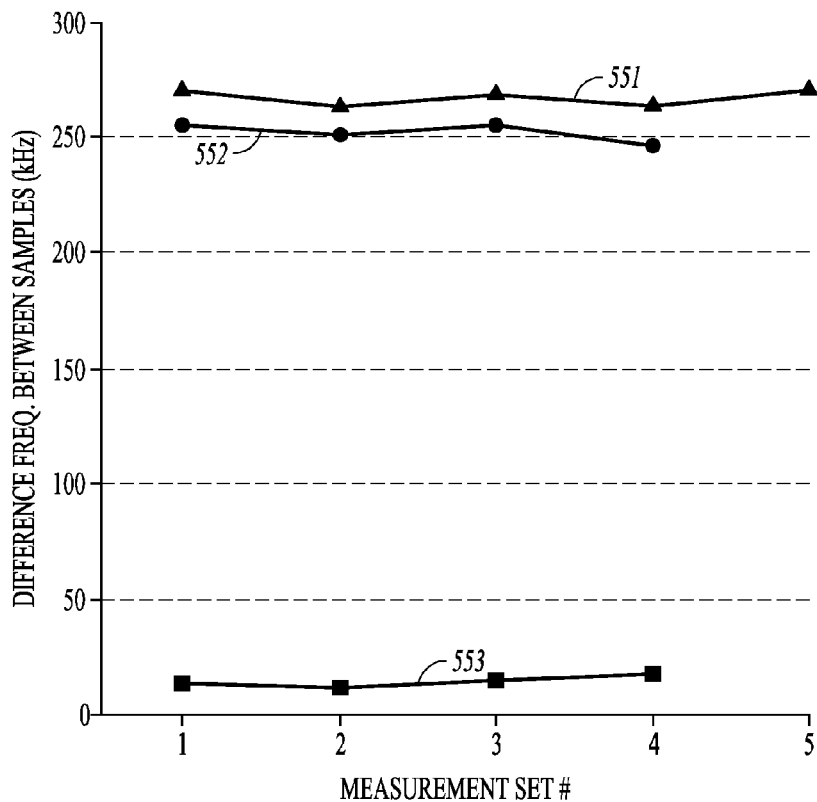

FIG. 5A

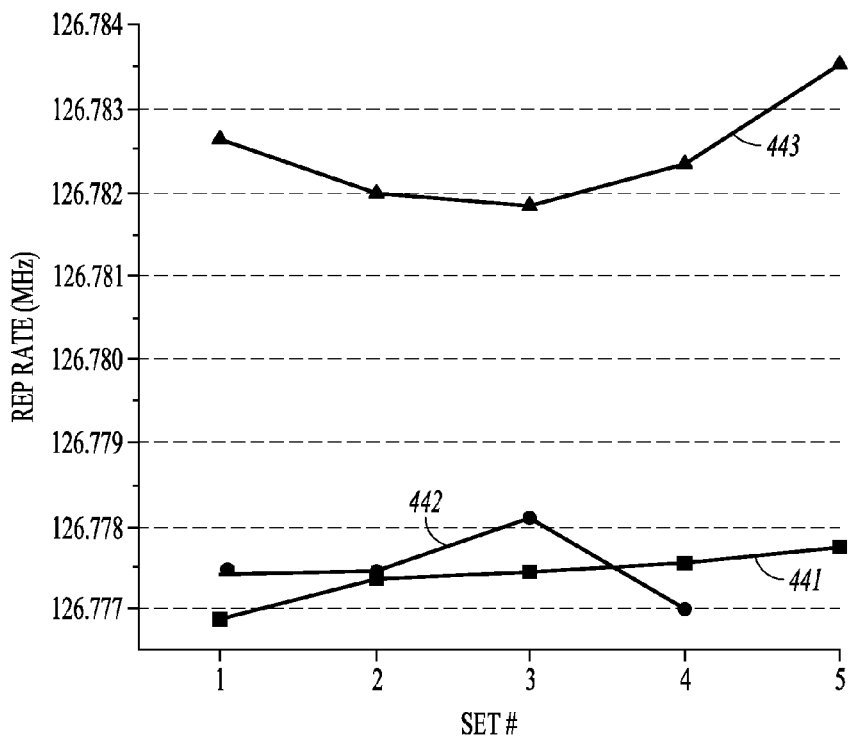

FIG. 5B

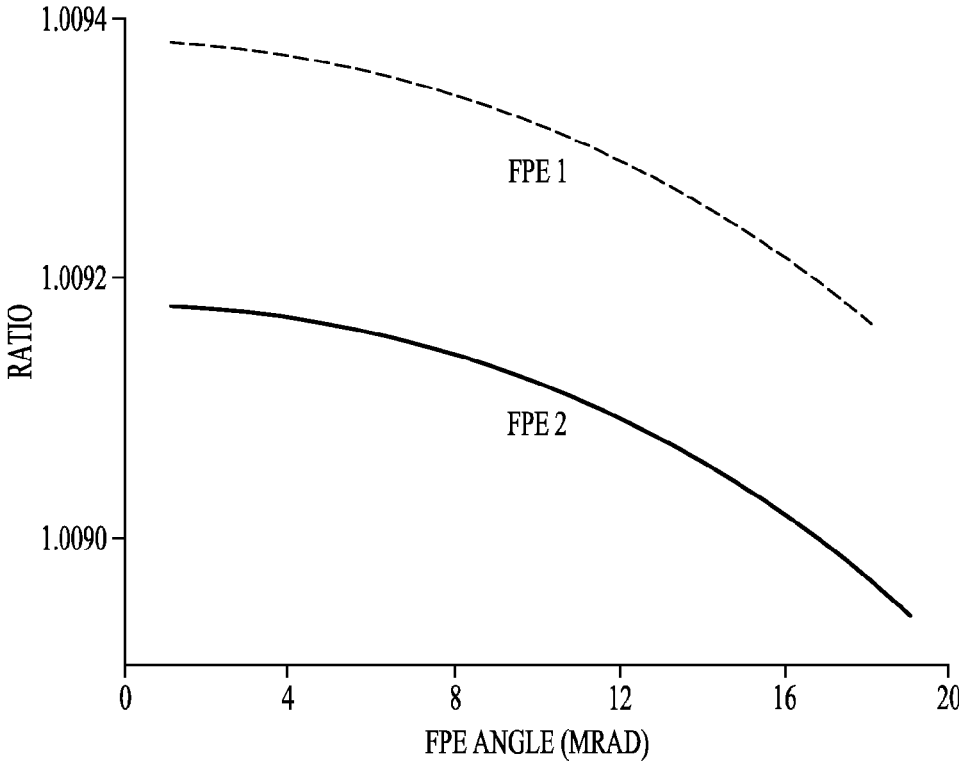

FIG. 6

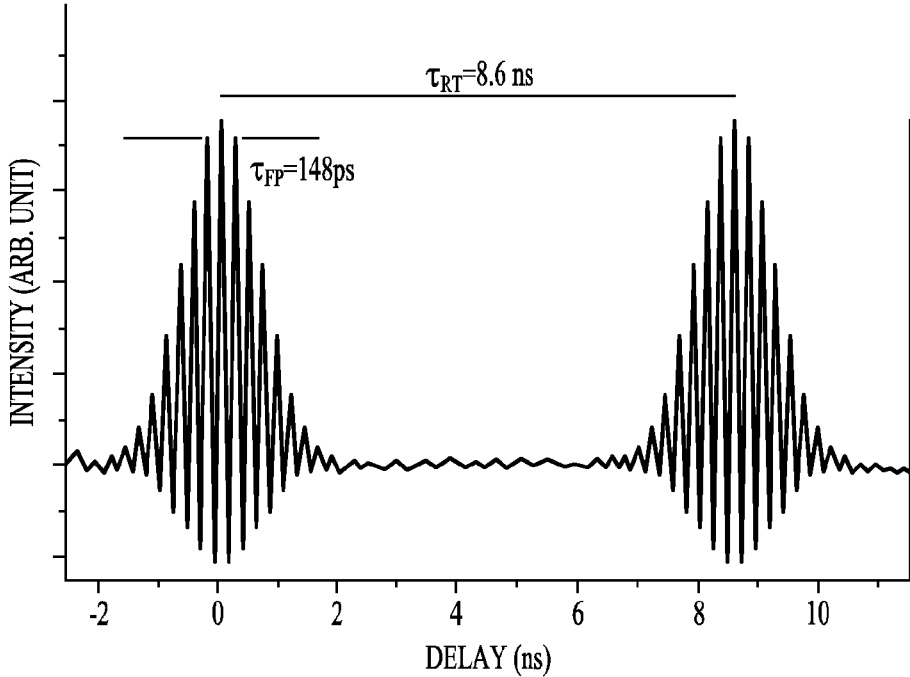

FIG. 7

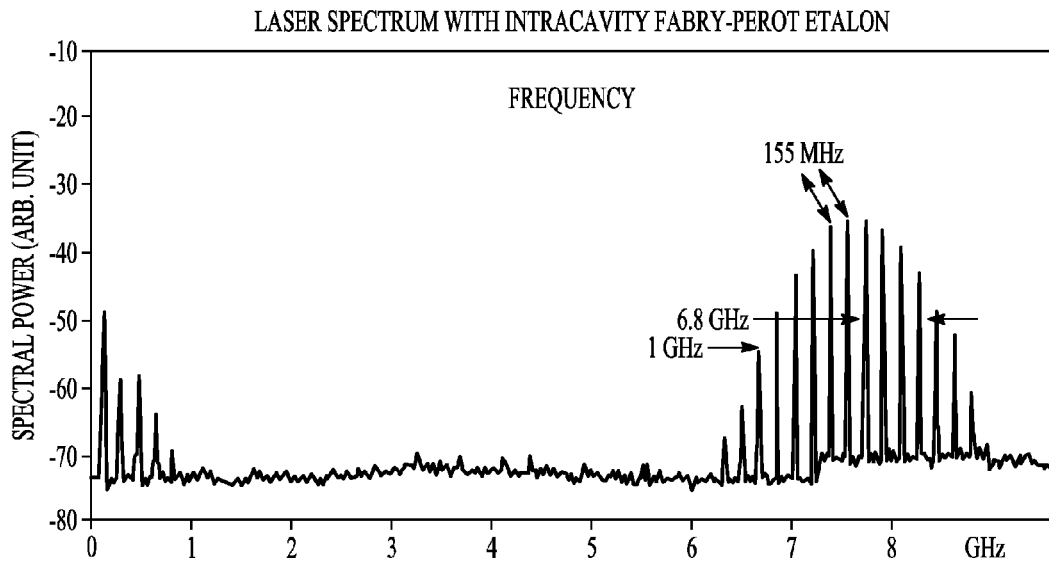

FIG. 8

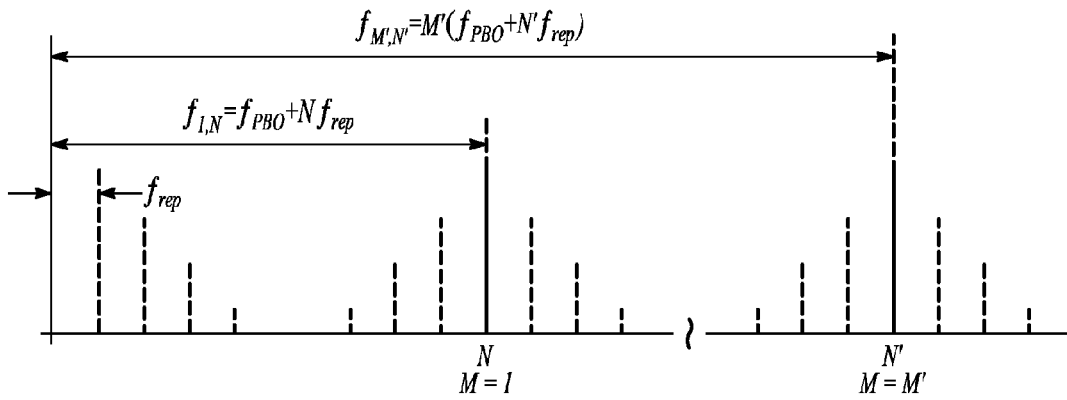

FIG. 9

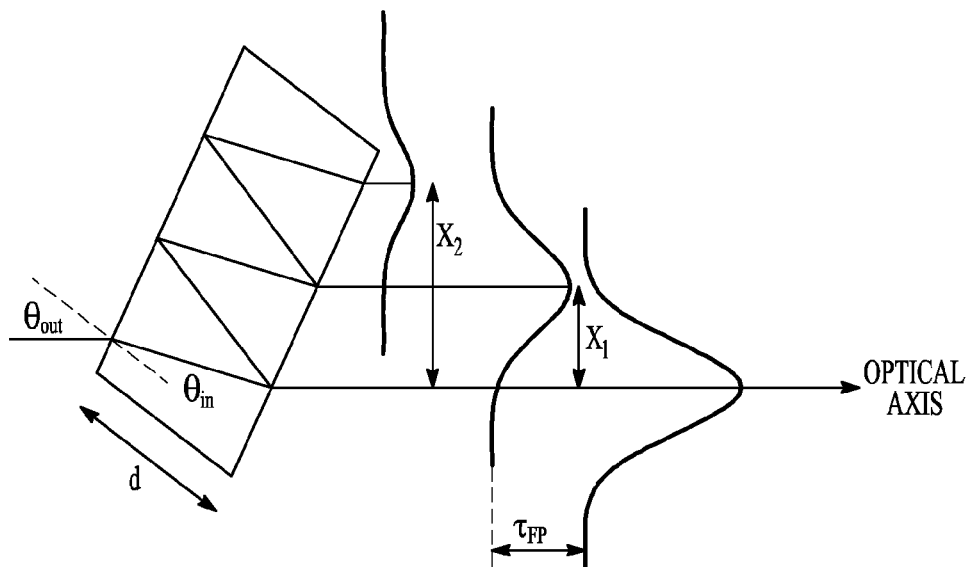

FIG. 10A

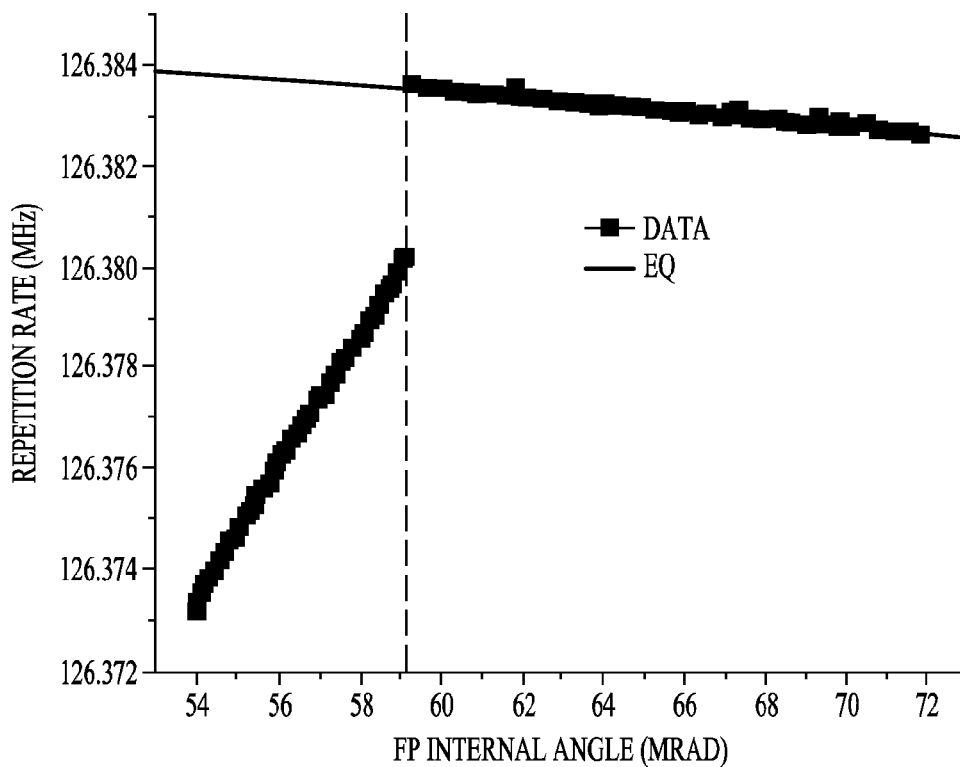

FIG. 10B

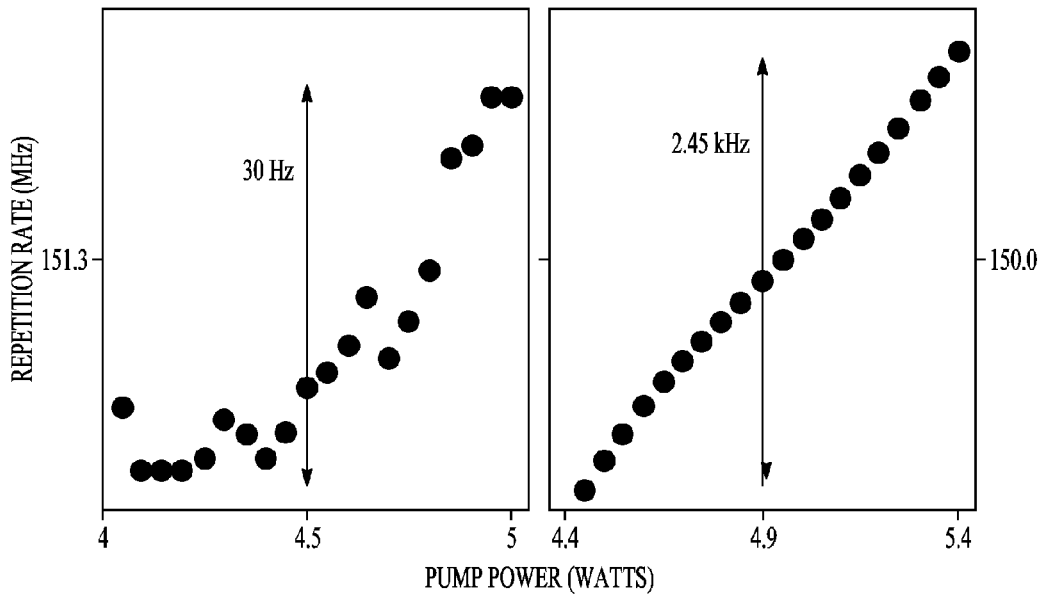

FIG. 11

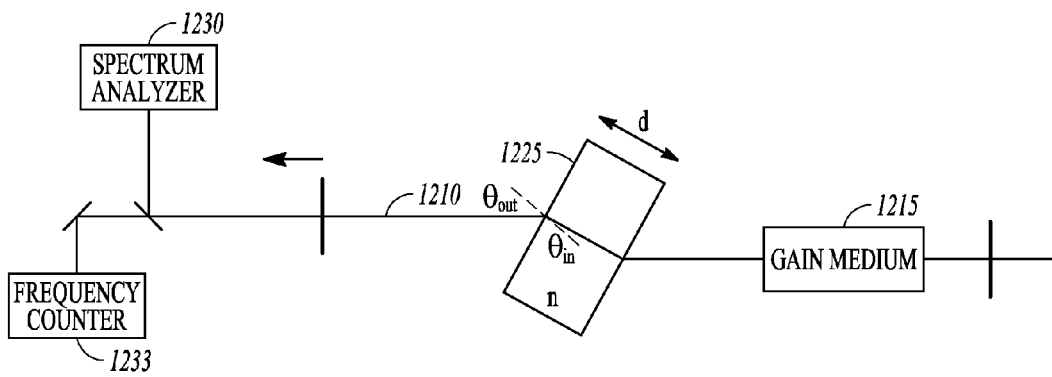

FIG. 12



FIG. 13A

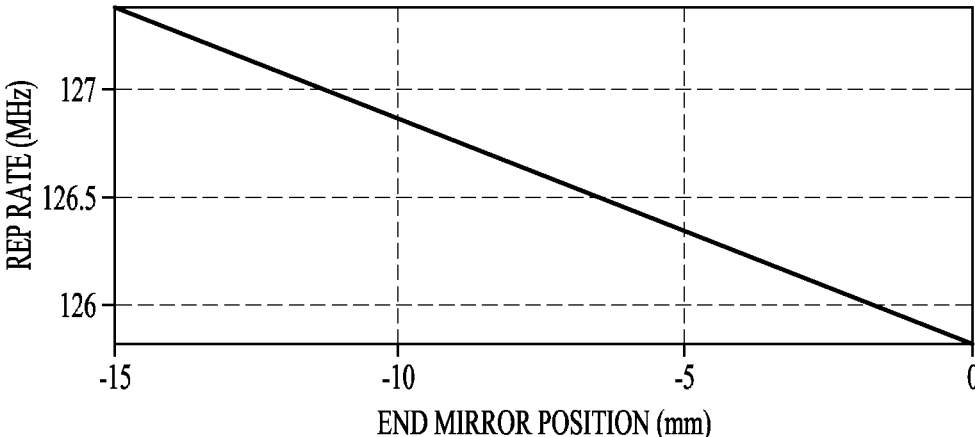

FIG. 13B

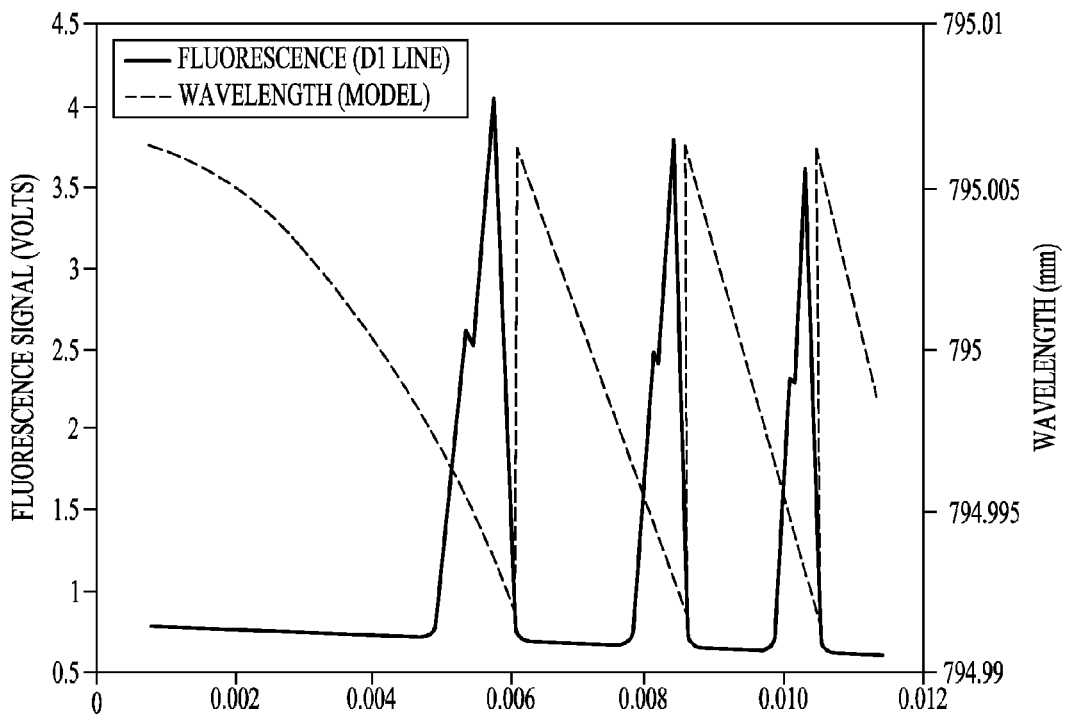

FIG. 14

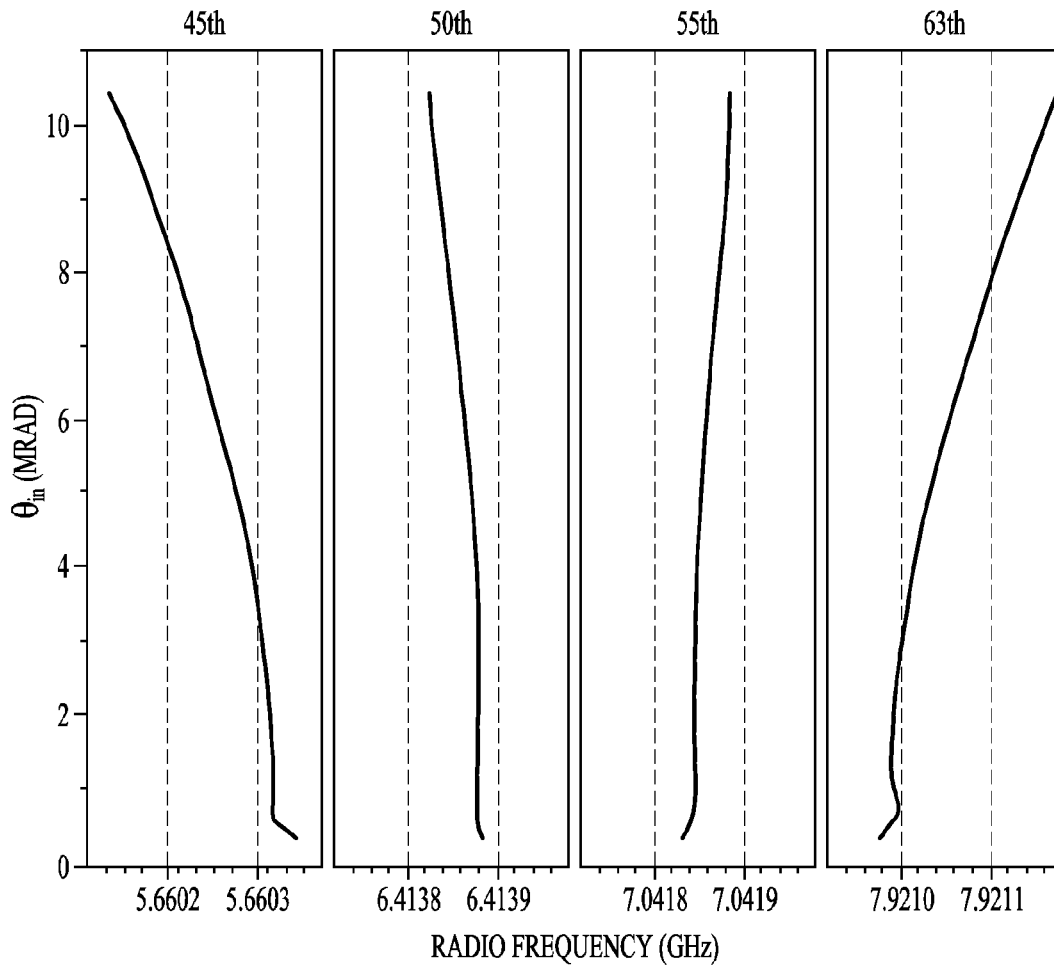

FIG. 15

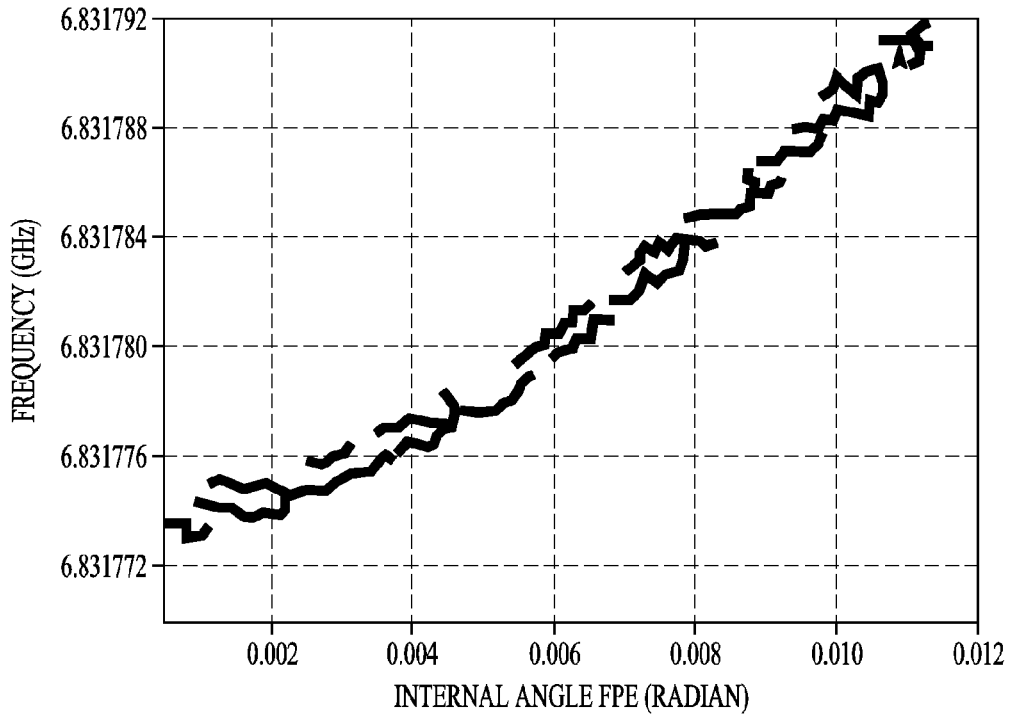

FIG. 16

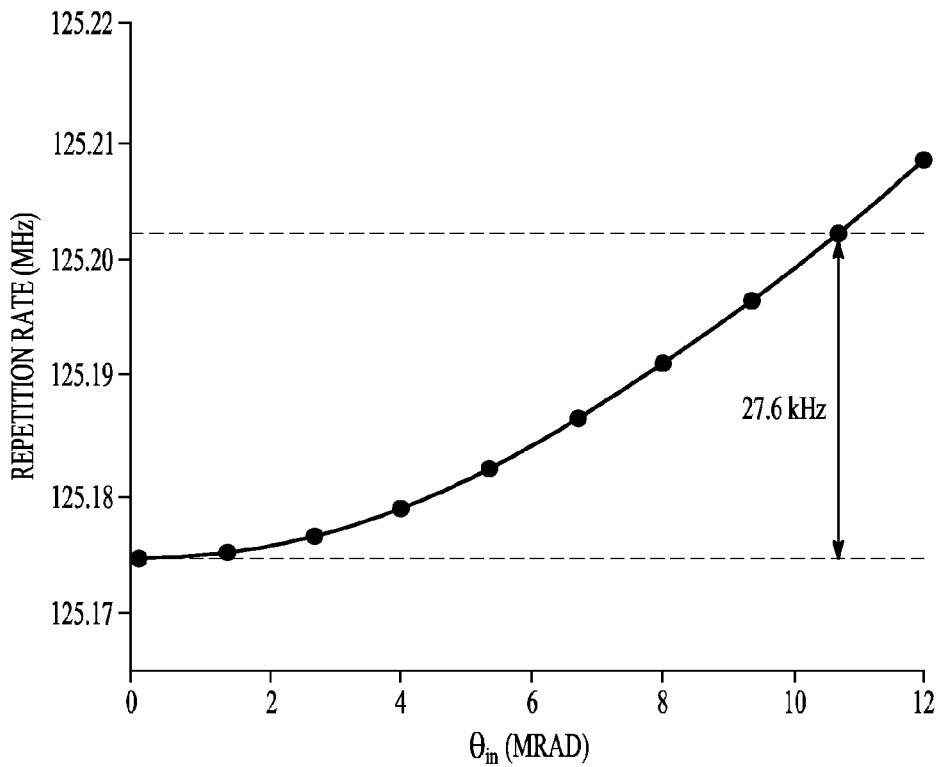

FIG. 17

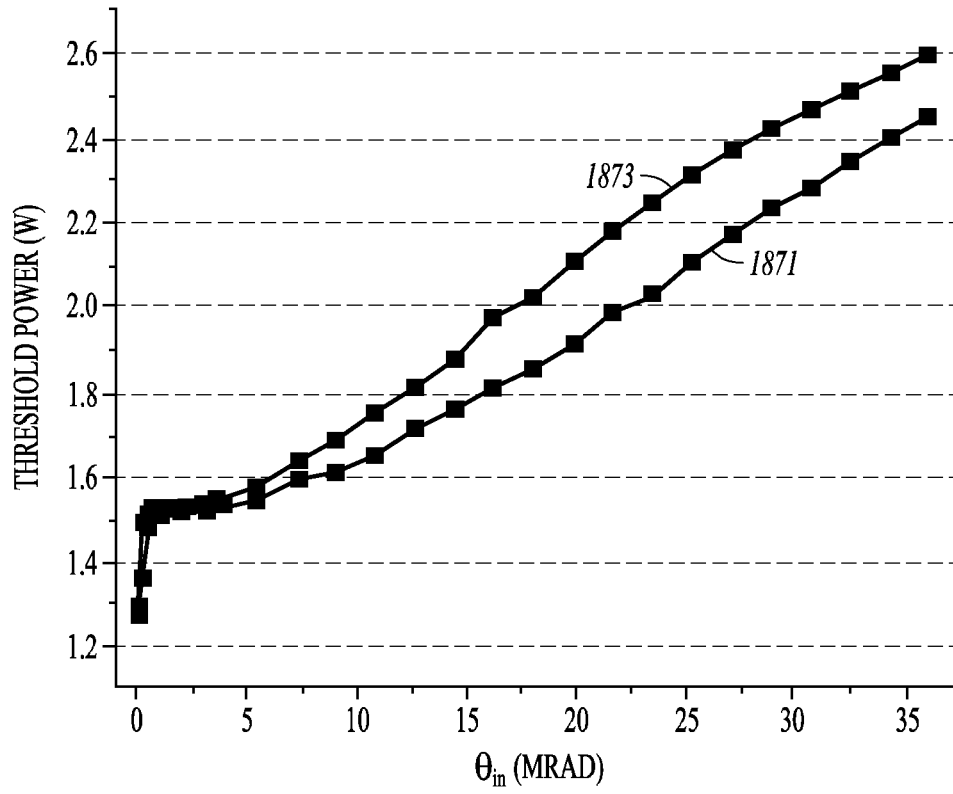

FIG. 18

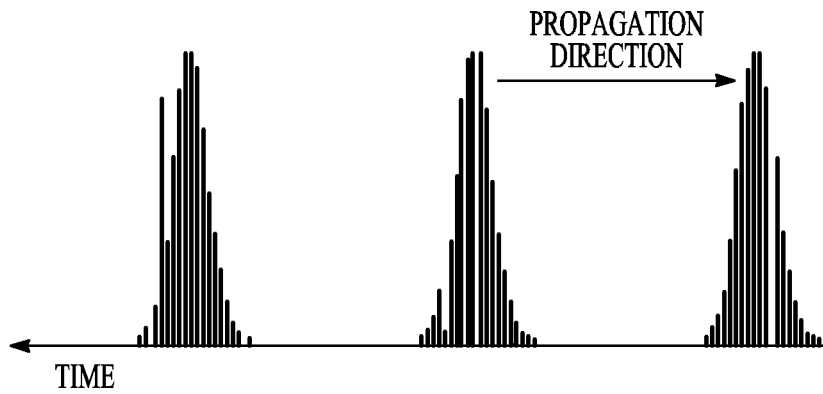

FIG. 19

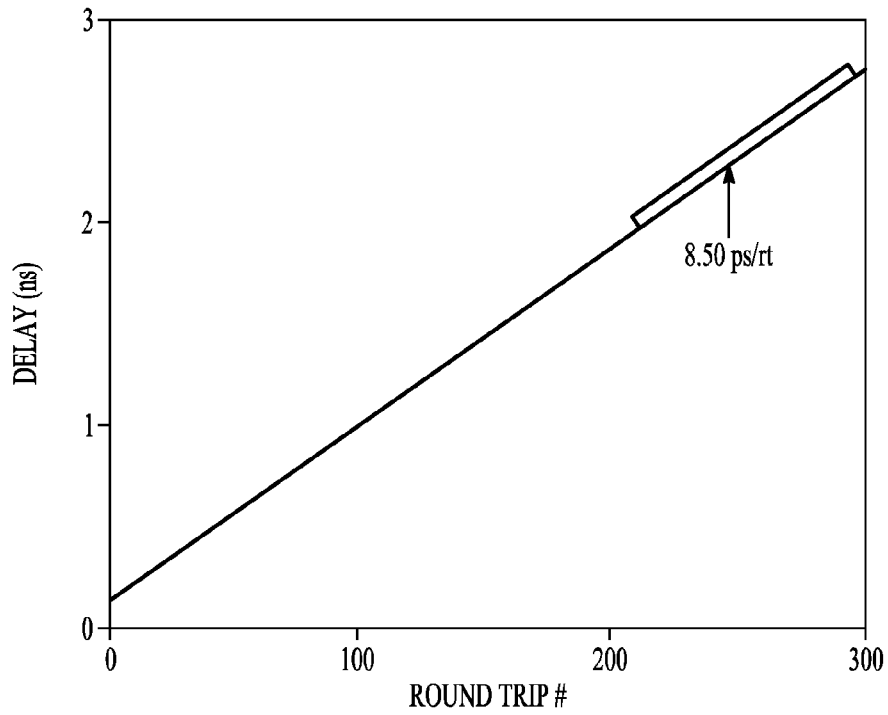

FIG. 20

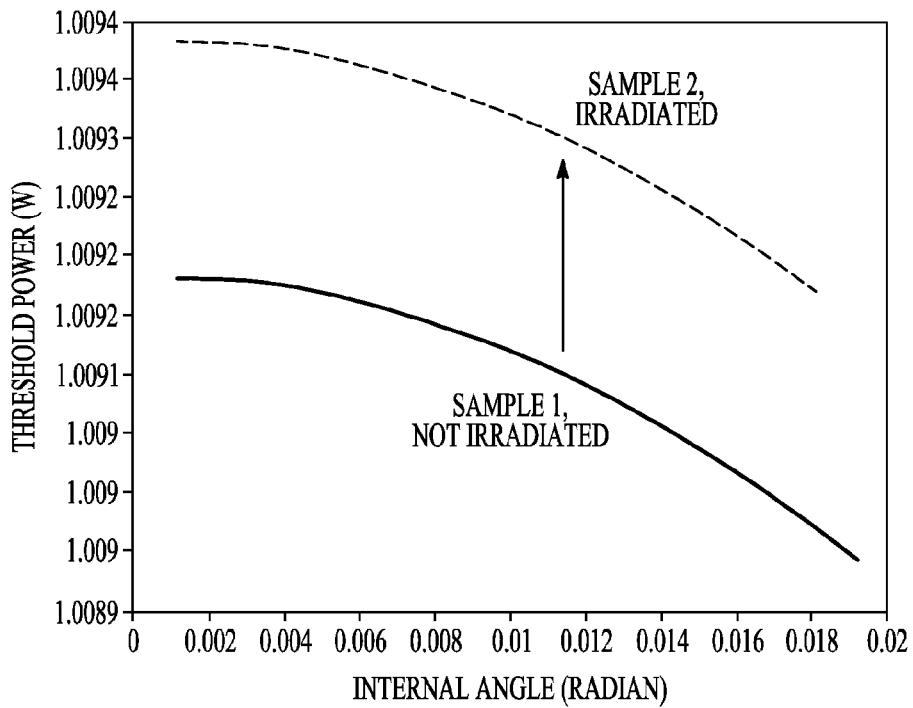

FIG. 21

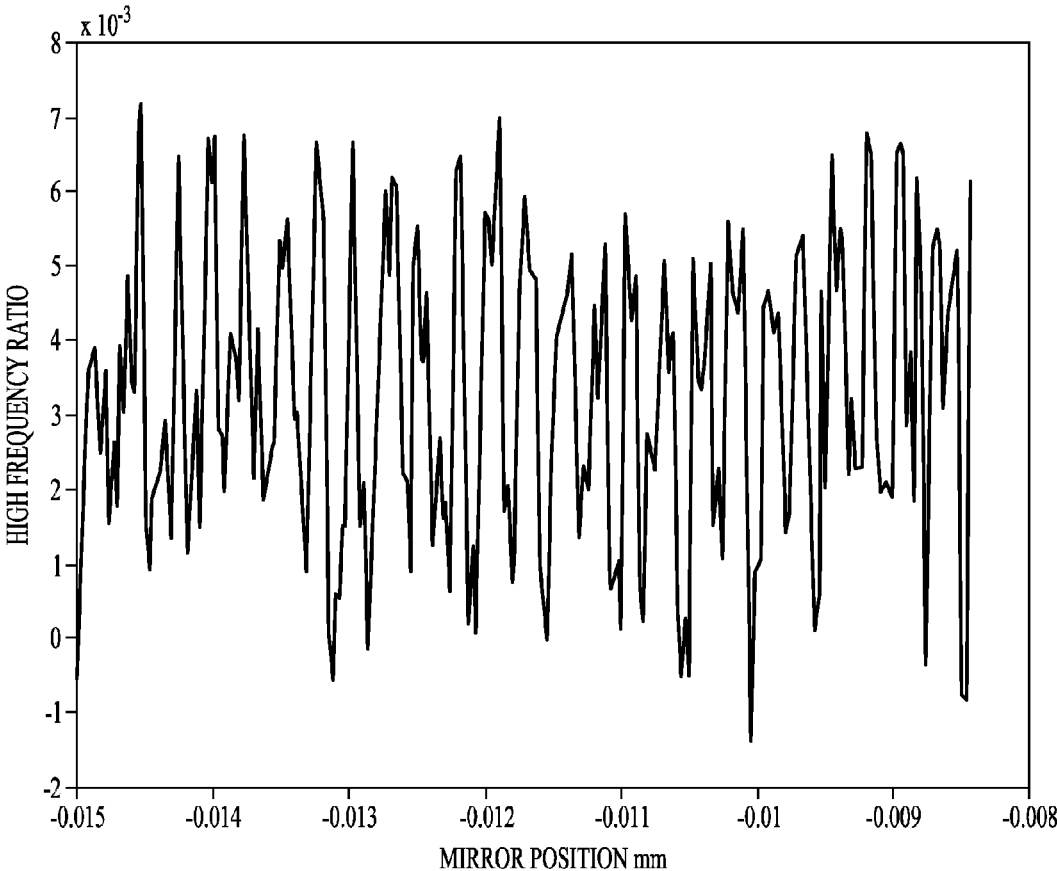

FIG. 22

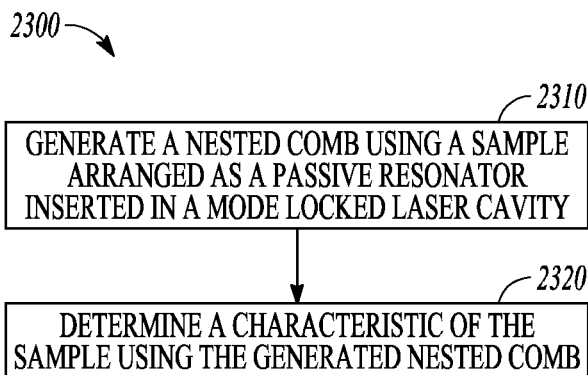

FIG. 23

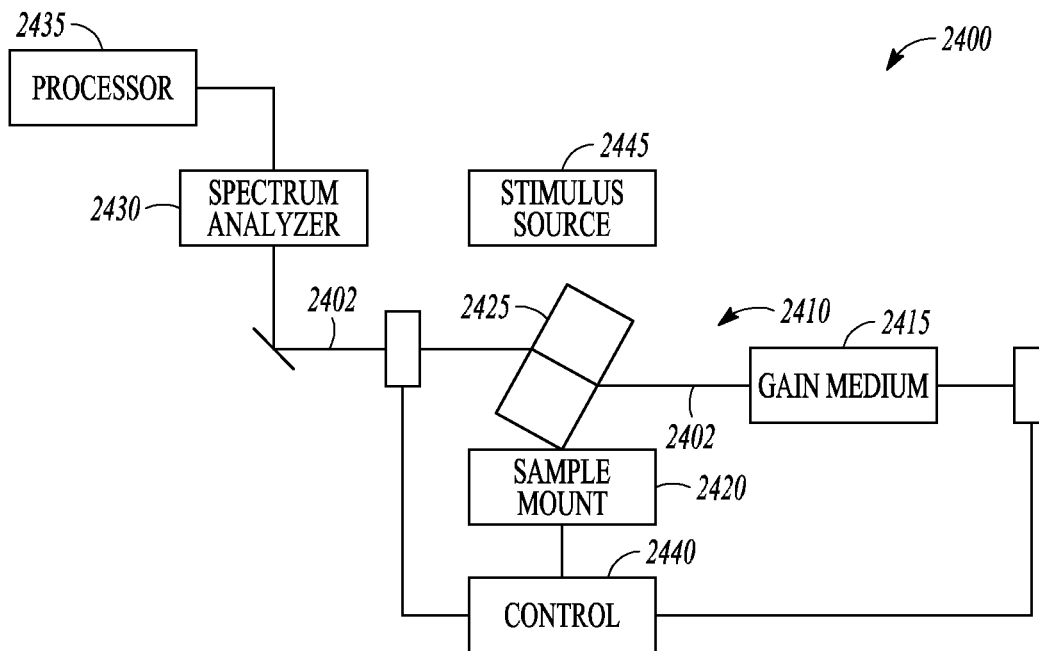

FIG. 24

NESTED FREQUENCY COMBS

RELATED APPLICATION

This application claims priority under 35 U.S.C. 119(e) from U.S. Provisional Application Ser. No. 61/902,063, filed 8 Nov. 2013, which application is incorporated herein by reference in its entirety.

FIELD OF THE INVENTION

The invention relates generally to frequency combs and to systems and devices for the generation and/or use of the same.

BACKGROUND

An optical frequency comb is an optical spectrum of equidistant lines. The use of frequency combs as a tool may depend on the spacing between teeth (lines) of the comb. Mode-locked lasers can provide accurate frequency combs. A mode locked laser produces a stream of identical pulses, which can have a duration of only several femtoseconds, at a repetition rate typically in the range of 70 to 150 MHz. In the frequency domain, the laser output consists of a frequency comb having equidistant lines. Because these lines are exactly equally spaced, this frequency comb can be used as a ruler for optical frequencies. Frequency combs may provide enhancements in other areas of measurement.

BRIEF DESCRIPTION OF THE FIGURES

Embodiments of the invention are illustrated by way of example and not limitation in the figures of the accompanying drawings in which:

FIG. 1 is a sketch of transmission through a Fabry Perot structure inserted in a cavity.

FIG. 2 illustrates the change in cavity length with internal angle of a Fabry Perot structure.

FIG. 3 shows ratio of the Fabry Perot frequency to repetition rate as a function of the Fabry Perot angle.

FIG. 4A shows measurements of the high frequency mode of a Fabry Perot etalon for three samples, measured with a 26 GHz spectrum analyzer over 1 min.

FIG. 4B shows five measurements of the high frequency mode of a Fabry Perot etalon for three samples, measured with a 26 GHz spectrum analyzer over 1 min.

FIG. 5A shows difference of the high frequencies between the samples for each measurement set of FIG. 4B.

FIG. 5B shows difference of the repetition rate between the samples for each measurement set of FIG. 4B.

FIG. 6 shows the ratio between the high radio frequency and low radio frequency plotted as a function of the Fabry Perot etalon angle for two different Fabry Perot etalons of the same index but with slightly different thickness.

FIG. 7 shows an example of a round-trip group delay of a Fabry Perot structure with respect to group delay of the laser cavity in which the Fabry Perot structure is disposed.

FIG. 8 shows an example of a spectrum associated with a Fabry Perot etalon in a mode-locked laser cavity.

FIG. 9 shows an example of a relationship for frequency related to the frequency associated with the Fabry Perot structure and the frequency of the repetition rate of the mode-locked laser cavity in which the Fabry Perot structure is inserted.

FIG. 10A shows a number of pulses with peak amplitudes at different distances from the optical axis.

FIG. 10B shows repetition rate of the laser as a function of the internal angle of a Fabry Perot etalon.

FIG. 11 shows the effect of the pump on the repetition rate.

FIG. 12 shows a measurement arrangement including a laser cavity of a mode-locked laser having a gain medium and a Fabry Perot etalon mounted in the laser cavity.

FIG. 13A shows a relationship of the high frequency component of the nested comb to the end mirror position for the arrangement of FIG. 12.

FIG. 13B shows a relationship of the repetition rate to the end mirror position for the arrangement of FIG. 12.

FIG. 14 shows a wavelength model associated with optical frequency tuning of the arrangement of FIG. 12.

FIG. 15 shows a relationship of internal Fabry Perot etalon angle and radio frequency for the high frequency component of the nested comb.

FIG. 16 shows frequency as a function of the internal angle of the Fabry Perot etalon for the high frequency part corresponding to the wide spacing comb in frequency domain.

FIG. 17 shows the repetition rate as a function of the internal Fabry Perot etalon angle for the low RF frequency.

FIG. 18 shows threshold power as a function of the internal Fabry Perot etalon angle for two Fabry Perot etalons of different thickness.

FIG. 19 is a presentation of the propagation of a bunch. FIG. 20 shows delay as a function of round trip number.

FIG. 21 shows the ratio of high frequency to low frequency as a function of internal angle of a Fabry Perot etalon for two scenarios.

FIG. 22 shows high frequency ratio as a function of mirror position providing an indication of resolution.

FIG. 23 is a flow diagram of features of an example method to characterize a sample.

FIG. 24 is a schematic of an example system structured to characterize a sample, a source that stimulates the sample, or both a sample and a source that stimulates the sample.

DESCRIPTION

The following detailed description refers to the accompanying drawings that show, by way of illustration and not limitation, various example embodiments of the invention. These embodiments are described in sufficient detail to enable those skilled in the art to practice these and other embodiments. Other embodiments may be utilized, and structural, logical, and electrical changes may be made to these embodiments. The various embodiments are not necessarily mutually exclusive, as some embodiments can be combined with one or more other embodiments to form new embodiments. The following detailed description is, therefore, not to be taken in a limiting sense.

Output of a laser cavity represents properties of its medium. In a single frequency comb, the group and phase index of the cavity defines the position and spacing between frequencies. For the case of nested cavity, a high frequency comb is generated from a Fabry Perot etalon that is inserted in a cavity. The frequency comb of the Fabry Perot etalon inherits the linewidth of the laser cavity without involving complications of a gain medium. Using these nested cavities, the index of refraction of the Fabry Perot etalon can be measured with ultimate precision by measuring the high frequency RF (Fabry Perot etalon) and low frequency RF (laser repetition rate). Performing cavity scans by a) tilting

the angle of Fabry-Perot and/or b) scanning of cavity length enhances the resolution in the index of refraction measurement.

Simple etalons inserted in a laser cavity of a laser can be used to tune the wavelength of the laser. Inserting such an element inside a mode-locked laser can lead to a frequency comb with counter-intuitive features. Instead of a decaying sequence of pulses, the etalon produces a symmetric bunch of pulses, at a repetition rate in the GHz range, that can be fine tuned with the laser cavity length. The wavelength of the laser—as in the continuous wave (cw) case—can be tuned with the angle of the etalon. However, in the case of the mode-locked laser, the high frequency (HF) of the Fabry Perot etalon and low frequency (LF) components of the repetition rate are both modified with the angle of incidence. As a result, a nested comb can be generated on a mode-locked comb. For example, a nested comb of 6-10 GHz can be generated on a mode-locked comb of around 100 MHz in a meter long Ti:Sapphire laser.

This unique design combines the narrow line width of the laser cavity, which is a Fabry Perot (FP) structure with gain, with the accessible Fabry-Perot sensor as an etalon, where the sensor can be arranged as a workpiece. For example, the workpiece can be a piece of glass or other transparent material arranged as a FP etalon. Tuning parameters and coupling of the nested frequency comb can be adjusted for application in measurement of refractive index. Examples of using methods discussed herein includes, but is not limited to, measuring the change of the index of refraction of a sample as a function of a stimulus applied to the sample. For example, the change of index was measured and recorded for a 1.4 cm etalon of CaF_2 that had been exposed with PuBe with 6 curie (Ci) of radiation.

In various embodiments, architectures with one or more passive etalons inserted in a mode-locked laser cavity can provide precise and selective radiation sensing. Methods using such architectures can be implemented in, but are not limited to, applications detecting neutrons and/or detecting and discerning gamma (γ) rays from neutrons. Architectures with one or more passive etalons inserted in a mode-locked laser cavity can provide a mechanism to sense changes of indices of refraction with utmost sensitivity. These architectures and methods can be utilized to investigate the immediate and long term impact of different radiation on the index of refraction and other optical properties of materials, and use data collected to identify different radiation. The extent of radiation induced refractive index change in optical materials can be determined as a function of the amount of radiation irradiating the respective optical materials. In addition to radiation exposure history determination, these architectures and method may be utilized to control materials properties with great precision to create novel materials and devices having advanced functionality.

Radiation damage from neutrons is dominated by atomic lattice displacements and damage from gamma rays is dominated by electron displacements. Electron displacements cause color centers that can be detected through discrete absorption lines. Sensor elements can include ionic crystals and semiconductors. In ionic solids, such as CaF, LiF, NaCl, NaF, neutrons displace atoms by recoils of primary knock-out atoms (PKA), which then displace many more secondary ions. As long as the energy transferred in a neutron collision is higher than the displacement energy (typically tens of eV) then a PKA may be released, causing a cascade of displacement. As an example, it has been reported that a 0.5 MeV neutron on iron may cause 350 displacements from a single PKA. As the neutron scatters

down several hundred times in the material, each time producing a PKA, the total lattice displacement damage due to a single neutron can be tremendous. The best selection of two crystals may be realized for differential measurement for a dual neutron-gamma sensor.

Displacement damage due to neutrons is of course a function of displacement energy for that material, but it is also tied to the damage efficiency for the recoiling PKA. For the same incident neutron energy, lighter ions recoil with more energy than heavier ions, which should produce more atomic displacements, but they also share a larger portion of their energy with electrons, producing color centers. For small crystals (mm scale) the neutron mean free path at fission neutron energies reduces the probability of multiple scatters in the material, reducing the energy transfer to a single neutron collision, so for small samples lighter ion crystals should show more total displacements. The measurement configuration can be applied to materials composed of lower mass ions and of higher mass ions to examine their different response. LiF appears to be a good light mass candidate, since it has excellent optical qualities over a very large bandwidth. Li neutron absorption can also aid in energy absorption.

In contrast to neutron induced damage, gamma ray damage is strongly dominated by production of color centers due to the interactions primarily with electrons, with very little atomic displacement due to subsequent fast electron collisions. Gamma-ray interactions are dependent on proton number (Z), and as Z increases with atomic mass (A), a lower atom mass crystal will reduce this effect. Color centers lasers have a very high cross section of absorption and emission. The color center formed (F_2 , F_2^+ , F_2^- , and F_3^+) and its lifetime depends on the temperature of the sample, the energy and nature of the irradiating radiation (g-ray, electron beam, x-ray, UV, or ionic bombardment). The response of the same LiF sample to gamma rays can be compared with neutron response, as well as lead phosphate glasses in which the absorption line shifts to lower energy with high gamma radiation. Traditionally, the color centers are monitored with measurement of absorption lines. In this method, the index of refraction which follows the absorption through Kramers Kronig relation can be measured.

Response to radiation fields such as fission spectrum neutrons and gamma/x-rays in the low energy (<100 keV) and higher (^{60}Co) energy regimes can be studied using methods related to nested frequency combs. Since materials respond differently to different radiations based on A and Z , the optical response for low atom and high ion mass crystals can be characterized.

In various embodiments, architectures and techniques can be implemented with a mode-locked laser cavity. For example, a nested comb can be generated to characterize materials. The generation of nested comb can be realized using a passive resonator, such as a Fabry Perot etalon (FPE), inserted in a mode-locked laser cavity. The gain dynamics inside the laser can result in the generation of two nested frequency combs. The resonant condition couples these frequencies. This coupling provides a unique environment to measure phase and group index of the laser cavity and the etalon. The absolute optical frequency can be determined by the phase index in the etalon and phase index in the laser cavity. The high RF (radio frequency) frequency is defined by the optical length of the etalon and the group index of the cavity. The coupling between low RF (repetition rate) and high RF frequency determines the group and phase index of refraction. Scanning the cavity length of the laser

5

resonator and angle tuning of the etalon provides higher precision to the index measurement.

The optical frequency of the laser cavity is set by the Fabry Perot structure inserted in the laser cavity. This resonance set is for the central frequency lasing in the laser cavity, in other words, it basically has nothing to do with pulse operation. In order to have a constructive interference between the two passages in a small Fabry Perot structure with thickness, d , and index of refraction, n , at normal incidence, the phase difference, Φ_{FP} , between the two passage should be a multiple of 2π ,

$$\Phi_{FP}=2kdn=2N\pi. \quad (1)$$

As the Fabry Perot structure is rotated, a change in phase is induced, the resonance should persist and the phase has to stay multiple of 2π

$$\Delta\Phi_{FP}=2kdn \cos(\theta)=0 \text{ or } 2\pi \text{ or } 4\pi. \quad (2)$$

As the internal angle of Fabry Perot structure changes for the range of 0.01 radian the optical frequency undergoes 3 oscillations with amplitude of Fabry-Perot frequency. The absolute optical frequency can only change by maximum of ν_{FP} . One can confirm this frequency change by looking at the fluorescence of D1 line of rubidium, where three resonances can be observed.

The optical frequency is set by the resonance in the Fabry Perot structure. This effect can be examined and compared with a Fabry Perot structure outside a laser cavity. When placed outside the cavity, the phase change due to rotation of the Fabry-Perot can be converted to time delay between the pulses, inside the laser it is converted to change in optical frequency. When inserted in the cavity the rotation of the Fabry Perot structure does not change the timing between the pulses.

In a laser cavity of a mode-locked laser, the generated signal deals with pulses not a continuous wave. The Fabry-Perot structure is a slave passive cavity inside a laser cavity with gain. There is an offset frequency between optical frequency and Fabry-Perot frequency associated to the bunch generated. A passive cavity has a dispersion resulting to unequally spaced modes in frequency. Insertion of the FP inside a laser cavity results in soliton solution. The modes of the FP cavity can now be equally spaced. This comb is a comb with zero offset frequency because there is no gain mechanism to impose a phase shift between carriers.

In order to have the same carrier to envelope phase for the picosecond pulses, there is a minute change in the group velocity of the picosecond pulses; note that this change in time is at most only a fraction of the light period. For a 2 picosecond pulse, a change of quarter light period is $\Delta\tau_{FP}=2.7/4=0.6$.

$$(\Delta\tau_{FP}/\tau_{FWHM})=(\Delta\nu_{FP}/\nu_{FWHM}) \quad (3)$$

So the group velocity of the Fabry Perot frequency is only 0.6 fs/148 ps or 27 kHz. The change of phase mentioned in the previous part in the frequency of Fabry-Perot pulse was not seen.

As the frequency in the cavity is changed, the total phase in the cavity modifies. This modification will result in the total phase delay being compensated with the group delay in order to keep the offset frequency between optical frequency and repetition rate constant. In other words, the total phase experience of the phase frequency changes not by changing length, only by changing frequency. One can say that this even happens in a laser cavity with birefringence, but in this case, the optical periods are not forced by a Fabry-Perot structure and there is no change in the gain mechanism while

6

rotating a Fabry-Perot structure. The total phase experience is kL in half cavity length. So the change of frequency initiated from the FP resonance imposes a phase change on the phase of the laser cavity. This phase change is proportional to $2\Delta k$ for one passage through the Fabry-Perot structure.

Because of the geometry of the problem, by having a FP structure inside the laser cavity, the total phase change with be $\Delta\Phi=2\times 2\Delta kL$ in half cavity round trip. This will result in

$$(\Delta\nu_{rep}/\nu_{rep})=(4\times\nu_{opt})=4\times 6\times 10^{-5}, \quad (4)$$

which will result in 37 kHz change in the repetition (rep) rate. Note that this corresponds to only one picosecond change in time, less than a pulse width.

In dealing with mode-locked lasers, the traditional approach is to make a Fourier transform of identical pulses appearing at each cavity round trip. For the situation disclosed herein, a bunch of pulses is encountered at each cavity round trip. Consider the spectrum of this train by considering

$$E(\Omega)=\int E(t)e^{-i\Omega t}dt \quad (5)$$

Since a shift in delta function is just a phase in frequency domain

$$\delta(x-x_0)e^{-2\pi i k x} dx = e^{-2\pi i k x_0} \quad (6)$$

the series of delta functions in time domain can be seen in freq domain as

$$E(\Omega)=\int \delta(t-N_{FP}\tau_{FP})\delta(t-N_{rt}\tau_{RT})\tilde{E}_0 e^{-i\omega t} dt \quad (7)$$

since the pulses exist only for $t=N_{FP}\tau_{FP}+N_{rt}\tau_{RT}$. Note that N_{rt} goes from "0" to infinity while N_{FP} goes from -5 to 5 .

$$\begin{aligned} E(\Omega) &= \sum_{N_{rt}=0}^{\infty} \sum_{N_{FP}=-5}^{N_{FP}=5} \tilde{E}_0 e^{-i\omega(N_{FP}\tau_{FP}+N_{rt}\tau_{RT})} [1 + 2\cos(\omega\tau_{RT}) + 2\cos(2\omega\tau_{RT}) + \\ & 2\cos(3\omega\tau_{RT}) + 2\cos(4\omega\tau_{RT}) + 2\cos(5\omega\tau_{RT})] \end{aligned} \quad (8)$$

This Fourier transform does not provide any insight to the relation between optical frequency and high and low (repetition rate) RF frequency. If the high RF frequency is not an integer multiplication of the repetition rate, then in order to form a pulse train in the cavity the comb structure is discontinuous. This discontinuity is a matter of perception. One can say that the high RF frequency is not built upon the mode-locked comb structure, the new comb structure is shifted to a high frequency comb of the order of 10 GHz with sidebands of repetition rate that covers the bandwidth of a bunch (for a nanosecond bunch the spectrum bandwidth around each high frequency is 1 GHz). The Fourier transform shows for a given set of frequencies in the cavity what is the proper structure of a frequency comb and pulse train in time domain, without justifying the relation between those frequencies.

Consider the distances that light travels inside a Fabry Perot structure and in a laser cavity with physical dimension $MN=L$, as shown in FIG. 1.

$$AK = d \quad (9)$$

-continued

$$BXD = \frac{2d}{\cos\theta_{in}}$$

$$BC = 2d \tan\theta_{in} \sin\theta_{out}$$

$$\frac{AH}{AB} = \cos(\theta_{out} - \theta_{in})$$

$$AH = \frac{d \cos(\theta_{out} - \theta_{in})}{\cos\theta_{in}}$$

$$L = MA + AH + BC + DN$$

So far, physical distances have been considered and not the optical ones. The index of refraction, in terms of a phase index, n_p , arise from the Snell's law

$$n_p \sin \theta_{in} = \sin \theta_{out} \quad (10)$$

The phase difference between the two passages in the Fabry-Perot is

$$\Delta\Phi = 2k_0(n_p BXD - BC) = 2k_0 n_p d \cos \theta_{in} \quad (11)$$

This is a very non trivial result; it states that the phase difference between multiple reflections reduces as the glass is rotated away from the normal incidence. The single passage through the glass, $AB = d/\cos \theta_{in}$, however increases with θ , but the difference between one bounce and two bounces is reduced. FIG. 2 shows the change of cavity length with θ_{in} . FIG. 3 shows ratio of the Fabry Perot frequency to repetition rate as a function of the Fabry Perot angle for a number of samples.

As had been confirmed in dark line measurements, the central optical frequency can be tuned by rotating the Fabry Perot internal angle

$$2\omega_0 dn_{p-FP} \cos \theta = 2N_{FP}\pi \quad (12)$$

The pulse period, however is defined with a group index

$$\tau_{FP} = (2dn_{g-FP} \cos \theta)/c, \quad (13)$$

and the cavity pulse period by

$$\tau_{RT} = (2L n_{g-c})/c, \quad (14)$$

Since the optical frequency ω_0 must be resonant simultaneously with the Fabry Perot and the laser cavity, the following is obtained

$$\frac{2\omega_0 L n_{p-c}}{c} = 2N_c \pi \quad (15)$$

$$\frac{2\omega_0 dn_{p-FP} \cos \theta}{c} = 2N_{FP} \pi. \quad (16)$$

as a result

$$\frac{L n_{p-c}}{dn_{p-FP} \cos \theta} = \frac{N_c}{N_{FP}}, 1 = 2 \quad (17)$$

which is not necessarily an integer. Here one should remember that the Fabry-Perot transmission linewidth is much broader than the laser cavity and further apart in frequency. The optical frequency of the cavity is defined by the Fabry-Perot large spacing and its precise value is set by the sharper teeth of the cavity. The high RF is an existing frequency in a cavity just like the optical frequency and needs to be resonant with the cavity as well. One can replace the values

$$v_{FP} = \frac{c}{2d \cos \theta n_{gFP}} \text{ and } v_{RT} = \frac{c}{2L n_{gc}}$$

and reach to the resonant condition that locks the high RF with low repetition rate) RF frequency.

$$\frac{v_{RT} n_{g-FP} n_{p-c}}{v_{FP} n_{gc} n_{p-FP}} = \frac{N_c}{N_{FP}} \quad (18)$$

The coupling of the HF of an FPE and the LF of the repetition rate of the laser can be exploited for a high resolution measurement of a small change in the index of refraction of the FPE. The coupling of HF and LF arises because of the simultaneous resonance of the two cavities. The ratio of HF to LF as given as

$$(f_{FP}/f_{rep}) = (n_{gFP} n_{p-FP} N_L) / (n_{gFP} n_{p-L} N_{FP}) \quad (19)$$

must be very close to an integer in order for the HF pulse train to form. The first term of the right hand side is a ratio of the group index of the laser cavity to that of the FPE, which are predominantly determined by pulse dynamics due to gain-loss balance and to the condition for the build-up of the HF pulse train. The third term is a ratio of integers that are determined by the physical dimension of the cavities, L and d. Therefore, the first and the third terms remain the same as long as the cavity conditions, including pump power, alignment, and cavity length, are unchanged. Now, the second term is a ratio of the phase index of refraction of the FPE to that of the laser cavity, which are unique physical quantities to the material of the object. Assuming the cavity conditions are unchanged, if there is a change in the index of refraction of FPE, it will be reflected to the ratio of HP to LF.

It is known that bombardment of high-energy particles, such as neutrons, can damage the lattice structure of crystals. Changes in the lattice structure (dislocations) should impact the index of refraction of the material. For trial experiments, several samples of CaF_2 were irradiated by a neutron beam with different dosage.

A detection of a change in the index due to radiation damage can be based on difference of the HF-LF ratio between pre- and post-irradiation. Therefore, all the cavity conditions, including the cavity gain (loss) and cavity alignment, are kept constant over the course of measurement. Initial experiments were made to test the system's consistency. Three CaF_2 FPEs were used for these experiments. Their physical thickness, measured based on mechanical measurement, are listed in Table I. Each FPE sample was placed on a mount, which was fixed in the cavity, and the FPE high frequency mode and the laser's repetition rate were recorded using a 26 GHz RF spectrum analyzer and a frequency counter for 1 min. FIG. 4A shows data from one set of the measurement for sample 441, sample 442, and sample 443. Sample 441 has a mean of 16.235409634 GHz and standard deviation of 287.55079 Hz. Sample 442 has a mean of 16.235395378 GHz and standard deviation of 561.60988 Hz. Sample 443 has a mean of 16.23514051 GHz and standard deviation of 384.61657 Hz. After recording the two frequencies with one sample, another FPE sample was replaced without touching cavity optics, and the same measurements are repeated. Data for three samples comprises one data set. This procedure was repeated to make a total of 5 sets. FIG. 4B shows data results for all 5 measurement sets

for samples **441**, **442**, and **443**. Over the course of the measurement, there is a systematic shift of the frequency of all three samples.

TABLE I

Sample #	Thickness (mm)
1	6.4727
2	6.4740
3	6.5120

Differential measurement is more advantageous because it is less dependent on the cavity misalignment. Difference frequencies were calculated between the FPE high frequency mode for each sample within the same measurement set. For example, the difference frequency between the sample #1 and #3 in the measurement set #1 is $f_{13}=f_1f_3$. The result is shown in FIG. 5A. Curve **551** is the difference frequency between the sample #1 and #3 at 267.16 ± 3.24 kHz. Curve **552** is the difference frequency between the sample #2 and #3 at 251.99 ± 3.97 kHz. Curve **553** is the difference frequency between the sample #1 and #2 at 14.33 ± 2.67 kHz. The same analysis was performed for the repetition rate, shown in FIG. 5B for samples **441**, **442**, and **443**.

The thickness of sample #3 was different from the other two samples by approximately 0.5% of its thickness. From the high frequency measurement in FIG. 5A, the resolution can be determined as

$$R=f_{13}/\Delta f_{13}=(267.16 \text{ kHz})/(3.24 \text{ kHz})=82.46 \quad (20)$$

In principle, it should be able to resolve 0.5%/82.5=0.006% change in thickness or equivalently in the index of refraction. For CaF_2 , with $n=1.4305$, it should be able to detect a change of

$$\Delta n=0.00006 \times 1.4305 \approx 10^{-4} \quad (21)$$

The width Δf_{ij} may be limited by the inaccuracy between the measurement sets. This can be improved by building more stable apparatus. With such stabilization, the ultimate width can be given by the fluctuation of the measurement within a set, which in the current data above is approximately 300 Hz at best. With this value, the resolution improves by a factor of 10.

FIG. 6 shows the ratio between the high radio frequency and low radio frequency plotted as a function of the FPE angle for two different FPEs of the same index but with slightly different thickness. The angular dependence of the ratio is due to the change in the cavity group index (the first term in (6.66)), which is affected by the gain-loss balance. What is remarkable in this measurement is that the two curves are nearly parallel. It means that the angular dependence of the gain-loss balance has not been changed between the two measurements. Only change made between the two measurements are the thickness of the FPEs. The remarkable performance of this method implies that the sensitivity can be further improved by two orders of magnitude ($\Delta n \sim 10^{-6}$).

In various embodiments, measurements of a material can include the generation of an interwoven frequency comb from a nested-cavity mode-locked laser. The interwoven frequency comb is composed of two frequency combs with different mode spacing, with the low frequency from the repetition rate of the laser cavity and the high frequency from the mini-pulse train generated due to an intracavity FPE. The properties of the new class of mode-locked laser, including the frequency tunability, dependence of the comb spacing on the gain and loss, the intricate coupling between

the low and high frequencies due to a coupled-cavity resonance condition, are scrutinized. An exploitation of the relation between the high and low frequencies through the cavity resonance can be exploited to measure characteristics of a material. A non-limiting example of such a measurement is the measurement of the index of refraction of a sample arranged as FPE. Application can be made to measure a small change in the index of refraction of the sample due to stimulus applied to the sample. Structural damage in a crystal by a nuclear radiation, as a stimulus, can be characterized by a nested comb.

From FIG. 1, Fabry-Perot transmission with the Fabry-Perot structure inserted in the laser cavity of a mode-locked laser can provide for generation of a nested comb having multiple combs. See, for example, U.S. Patent Application Ser. No. 61/902,063, filed 22 Jan. 2013, which application is incorporated herein by reference in its entirety. The Fabry-Perot transmission parameters include Fabry-Perot thickness, d , group index, n_g , phase index, n_p , field transmission function, \hat{T} , a round-trip phase shift, δ , and a round-trip group delay, τ_{FP} , given by:

$$\hat{T} = \frac{(1-R)e^{i\delta/2}}{1-Re^{i\delta}} \quad (22)$$

$$\delta = \frac{4\pi n_p d \cos\theta_m}{\lambda} \quad (23)$$

$$\tau_{FP} = \frac{2n_g d \cos\theta_m}{c} \quad (24)$$

FIG. 7 shows an example of a round-trip group delay, τ_{FP} , of a Fabry Perot structure with respect to group delay τ_{RT} of the laser cavity in which the Fabry Perot structure is disposed. FIG. 8 shows an example of a spectrum associated with a FPE in a mode-locked laser cavity, where the output of the laser can consist of bursts of a number of pulses at around 6.8 GHz, repeating at the cavity round-trip frequency of 155 MHz. FIG. 9 shows an example of a relationship for frequency related to the frequency associated with the Fabry Perot structure and the frequency of the repetition rate of the mode-locked laser cavity in which the Fabry Perot structure is inserted. This relationship is given by

$$V_{mn} = mV_{FP} + nV_{rep} \quad (25)$$

As previously noted, the FPE inserted in a laser cavity of a mode-locked laser can produce a symmetric bunch of pulses. The number of pulses in the bunch depends on number of pulses that can interfere. At each round trip of a signal in the laser cavity, a bunch of pulses can be formed by interferences, providing multiple combs, based on the length of the laser cavity, thickness of the Fabry-Perot etalon, and the beam size of the laser in the laser cavity. FIG. 10A shows a number of pulses with peak amplitudes at different distances 0 , x_1 , and x_2 from the optical axis. FIG. 10B shows repetition rate of the laser as a function of the internal angle of the FPE.

FIG. 11 shows the effect of the pump on the repetition rate. The effect of the pump on pulse period for a mode-locked laser cavity is shown on the left plot of FIG. 11. The effect of the pump on pulse period for a mode-locked laser cavity with the nested comb is shown in the left plot of FIG. 11.

FIG. 12 shows a measurement arrangement including a laser cavity **1210** of a mode-locked laser having a gain medium and a FPE **1225** mounted in the laser cavity **1210**. The measurement arrangement includes a spectrum analyzer

11

1230 and a frequency counter 1233. The FPE 1225 can be inserted in the laser cavity 1210 via a mount that provides control of the orientation of the FPE 1225 in the optical path of the laser. The arrangement of the mount may allow for a stimulus to be applied to the FPE 1225 for characterization of the FPE 1225 and/or the stimulus. FIG. 13A shows a relationship of the high frequency component of the nested comb to the end mirror position for the arrangement of FIG. 12. FIG. 13B shows a relationship of the repetition rate to the end mirror position for the arrangement of FIG. 12. The end mirror positioning can be used to provide high and low RF tuning.

FIG. 14 shows a wavelength model associated with optical frequency tuning of the arrangement of FIG. 12. FIG. 15 shows a relationship of internal FPE angle and radio frequency for the high RF frequency component of the nested comb. The indications 45th, 50th, 55th, and 63th refer to the division of the high frequency by the low frequency (integer part of that division). FIG. 16 shows frequency as a function of the internal angle of the FPE for the high frequency part corresponding to the wide spacing comb in frequency domain. FIG. 17 shows the repetition rate as a function of the internal FPE angle for the low RF frequency. FIG. 18 shows threshold power as a function of the internal FPE angle for two FPEs of different thickness, curve 1871 for a FPE of thickness of 10 mm and curve 1873 for a FPE of thickness of 15 mm.

In simulation of the generation of a nested comb, it is noted that there are two competing effects on the laser that result in the formation of a bunch. First, transfer of energy from one pulse to the next in Fabry-Perot delays the pulse bunch in the propagation direction. Second, due to saturation of the gain, the leading pulses in a bunch are amplified more, which advances the pulse bunch in the propagation direction. FIG. 19 is a presentation of the propagation of the bunch. FIG. 20 shows delay as a function of round trip number. Insertion of the Fabry-Perot reduces the pulse period 20 percent more than delay expected in the Fabry-Perot.

A nested comb can be used to determine the change of refractive index of a sample due to stimulus applied to the sample. For instance, application of a nested comb can be used to analyze the change of refractive index of a FPE in the laser cavity due to radiation of the FPE. The central optical frequency is resonant with both cavities:

$$\frac{2\omega_0 L n_{p-c}}{c} = 2N_c \pi \quad \text{and} \quad (26)$$

$$\frac{2\omega_0 d n_{p-FP} \cos\theta}{c} = 2N_{FP} \pi. \quad (27)$$

The high frequency is defined with a group index as

$$v_{fp} = \frac{c}{2d n_{g-fp} \cos\theta}. \quad (28)$$

The cavity pulse round-trip frequency is given by

$$v_{rt} = \frac{c}{2L n_{g-c}}. \quad (29)$$

12

The optical frequency ω_0 for the nested comb must be resonant simultaneously with Fabry-Perot structure and the laser cavity providing

$$\frac{v_{RT} n_{g-FP} n_{p-c}}{v_{FP} n_{pc} n_{p-FP}} = \frac{N_c}{N_{FP}}. \quad (30)$$

The optical frequency ω_1 must be resonant simultaneously with Fabry Perot and laser cavity:

$$\frac{2\omega_1 L n_{pL}}{c} = 2\pi N_L \quad \longrightarrow \quad \frac{L}{d} = \frac{N_L}{N_{FP}} \frac{n_{pFP}}{n_{pL}}$$

$$\frac{2\omega_1 d n_{pFP}}{c} = 2\pi N_{FP}$$

$$\frac{HF}{LF} = f_{FP} \times T_{rt} = \frac{2L}{c} n_{gL} + \frac{2d}{c} n_{gFP} = \frac{n_{gL}}{n_{gFP}} \frac{n_{pFP}}{n_{pL}} \frac{N_L}{N_{FP}}$$

All other conditions being equal, the ratio HF/LF measures the phase index of refraction of the FPE, n_{pFP} . Measuring this ratio before and after irradiation of the FPE allows for determination of the change of refraction due to radiation. Other stimuli applied to the FPE can be analyzed in a similar manner.

FIG. 21 shows the ratio of high frequency to low frequency as a function of internal angle of the FPE for two scenarios. Sample 1 is for a material structured as a FPE that is not irradiated. Sample 2 is for the material structured as a FPE that is irradiated. At a selected internal angle, the ratio of the index of refraction of the FPE irradiated to the index of refraction of the FPE not irradiated is

$$\frac{(n_{p-fp})_2}{(n_{p-fp})_1} = 1.00000279 \text{ with standard deviation of } 3e-8. \quad (32)$$

FIG. 22 shows high frequency ratio as a function of mirror position providing an indication of resolution.

FIG. 23 is a flow diagram of features of an example embodiment of a method 2300 to characterize a sample. At 2310, a nested comb is generated using a sample arranged as a passive resonator inserted in a mode-locked laser cavity. The nested comb has multiple frequency combs. The sample can be arranged as a Fn. At 2320, a characteristic of the sample is determined using the generated nested comb. The characteristic can include an index of refraction of the sample. The mode-locked laser cavity has a cavity length and the sample can be arranged as a Fabry Perot etalon, where method 2300 or a similar method can include measuring phase and group index of the mode-locked laser cavity and the Fabry Perot etalon based on a resonant condition coupling the multiple frequency combs.

Method 2300 or a similar method can include applying a stimulus to the sample; and determining a change in the characteristic of the sample based on a change of the multiple frequency combs in response to the stimulus applied to the sample. The change in the characteristic of the sample can include a change in the index of refraction of the sample. The mode-locked laser cavity has a cavity length and the sample can be arranged as a Fabry Perot etalon,

13

where method **2300** or a similar method can include scanning the cavity length and angle tuning the etalon, providing higher precision to measurement of the index of refraction. Applying the stimulus to the sample can include irradiating the sample. Method **2300** or a similar method can include characterizing material of the sample as a function of parameters correlated to irradiating the sample. Method **2300** or a similar method can include generating a characterization of a source irradiating the sample. Irradiating the sample can include irradiating the sample with neutrons, gamma rays, or neutrons and gamma rays. Method **2300** or a similar method can include determining the index of refraction of the sample as a function of irradiating the sample with neutrons.

Method **2300** or a similar method can include generating a nested comb using another sample arranged as a passive resonator inserted in a mode-locked laser cavity to generate multiple frequency combs, the other sample providing a reference. Crystals can be used as the sample and the other sample. Features discussed with respect to any of FIGS. **1-24** or combinations of features, as taught herein, may be appropriately combined into a method that uses a nested frequency comb according to the teachings herein.

FIG. **24** is a schematic of an embodiment of an example system **2400** structured to characterize a sample, a source that stimulates the sample, or both a sample and a source that stimulates the sample. System **2400** comprises a mode-locked laser **2405** having a laser cavity **2410**, referred to as a mode-locked laser cavity **2410**, a gain medium **2415**, and a sample mount **2420** disposed in mode-locked laser cavity **2410**. System **2400** can also comprise a spectrum analyzer **2430** and a processor **2435**. Sample mount **2420** can be disposed in mode-locked laser cavity **2410** such that a sample **2425** arranged as a passive resonator inserted in mode-locked laser cavity **2410** via sample mount **2420** is operable in conjunction with a laser beam of mode-locked laser cavity **2410** along propagation path **2402** to generate a nested comb having multiple frequency combs. The spectrum analyzer **2430** can be disposed to operably receive the multiple frequency combs. Processor **2435** can be coupled to spectrum analyzer **2430** to operatively determine a characteristic of sample **2425** based on the multiple frequency combs operably received by spectrum analyzer **2430**.

System **2400** or a similar system can include mode-locked laser cavity **2410** structured with an access path arranged such that a stimulus is operably applied to sample **2445**; and processor **2435** is operable to determine a change in the characteristic of sample **2425** based on a change of the multiple frequency combs in response to the stimulus applied to sample **2425**. The characteristic can be an index of refraction of sample **2425**. System **2400** or a similar system can include a control **2440** to scan the cavity length and angle tune sample **2425** when arranged as a Fabry Perot etalon, to provide higher precision to measurement of the index of refraction. Scanning the cavity length can include adjusting the cavity length.

System **2400** or a similar system can include an irradiating source **2445** to apply the stimulus to sample **2425**. System **2400** or a similar system can include processor **2435** operable to characterize material of sample **2425** as a function of parameters correlated to irradiating source **2445**. Irradiating source **2445** can include a neutron source, a gamma ray source, both a neutron source and a gamma ray source, or other stimulating source operable to stimulate **2425** without modifying other components of the mode-locked laser **2405**.

14

System **2400** or a similar system can include the sample mount **2420** structured to operably exchange samples into the mode-locked laser cavity **2419**, where each sample is arranged as a passive resonator inserted in a mode-locked laser cavity to generate multiple frequency combs. The samples as passive resonators can be structured as FPEs. Features discussed with respect to any of FIGS. **1-23** or combinations of features, as taught herein, may be appropriately combined into a system according to the teachings herein.

Although specific embodiments have been illustrate and described herein, it will be appreciated by those of ordinary skill in the art that any arrangement that is calculated to achieve the same purpose may be substituted for the specific embodiments shown. Upon studying the disclosure, it will be apparent to those skilled in the art that various modifications and variations can be made in the devices and methods of various embodiments of the invention. Various embodiments can use permutations and/or combinations of embodiments described herein. Other embodiments will be apparent to those skilled in the art from consideration of the specification and practice of the embodiments disclosed herein. It is to be understood that the above description is intended to be illustrative, and not restrictive, and that the phraseology or terminology employed herein is for the purpose of description.

What is claimed is:

1. A method comprising:

generating a nested comb having multiple frequency combs, the nested comb generated using a sample arranged as a passive resonator inserted in a mode-locked laser cavity; and determining a characteristic of the sample using the multiple frequency combs of the generated nested comb.

2. The method of claim 1, wherein the method includes: applying a stimulus to the sample; and determining a change in the characteristic of the sample based on a change of the multiple frequency combs in response to the stimulus applied to the sample.

3. The method of claim 2, wherein the characteristic is an index of refraction of the sample.

4. The method of claim 3, wherein the mode-locked laser cavity has a cavity length and the sample is arranged as a Fabry Perot etalon and the method includes scanning the cavity length and angle tuning the etalon, providing higher precision to measurement of the index of refraction.

5. The method of claim 2, wherein applying the stimulus to the sample includes irradiating the sample.

6. The method of claim 5, wherein the method includes characterizing material of the sample as a function of parameters correlated to irradiating the sample.

7. The method of claim 5, wherein the method includes generating a characterization of a source irradiating the sample.

8. The method of claim 5, wherein irradiating the sample includes irradiating the sample with neutrons, gamma rays, or neutrons and gamma rays.

9. The method of claim 8, wherein the method includes determining the index of refraction of the sample as a function of irradiating the sample with neutrons.

10. The method of claim 1, wherein the method includes generating a nested comb using another sample arranged as a passive resonator inserted in a mode-locked laser cavity to generate multiple frequency combs, the other sample providing a reference.

11. The method of claim 10, wherein the sample and the other sample are crystals.

12. The method of claim 1, wherein the mode-locked laser cavity has a cavity length and the sample is arranged as a Fabry Perot etalon and the method includes measuring phase and group index of the mode-locked laser cavity and the Fabry Perot etalon based on a resonant condition coupling the multiple frequency combs.

* * * * *